

JVC | Instruction Book

STEREO RECEIVER **JR-S400** *MARK II*



For Customer Use:

Enter below the Model No. and Serial No. which is located either on the rear or bottom of the cabinet. Retain this information for future reference.

Model No. _____

Serial No. _____

A Guide To This Instruction Book

Thank you for buying JVC's JR-S400 MARK II Stereo Receiver. You are now the owner of a sophisticated stereo receiver incorporating many advanced features. This book is divided into two sections. The first describes **basic** functions listening to radio broadcasts, playing records and tapes and recording tapes. The second section describes the more **advanced** functions, S.E.A., tape dubbing, the attachment of other devices, etc.

Before you read these, you should read the precautions. Wishing you happy and successful listening.

CONTENTS

Important	1
Front panel	2
Connection diagram	3
Connecting speakers	4
Antennas	4
Basic	
Listening to AM broadcasts	5
Listening to FM broadcasts	5
Listening to records	6
Listening to tapes	6
Recording tapes	6
S.E.A. recording	6
Using stereo headphones	6
Advanced	
S.E.A. Preset patterns	7
Some more about S.E.A.	7
Power meters	8
Tape dubbing	8
Connecting noise reduction unit	9
Using Pre-Out/Main-In terminals	9
FM Det Out	9
Troubleshooting	10
Specifications	10

IMPORTANT

1. Installation

- Select a place which is level, dry and neither too hot nor too cold (between -5° and $40^{\circ}\text{C}/23^{\circ}\text{F}$ and 104°F).
- Leave a space between the rear of the receiver and the wall.
- Do not allow a curtain, etc. to block the ventilation holes.
- Keep the receiver away from direct sunlight.
- Do not put it too close to a heater.
- Do not use it in a place subject to vibrations.
- Do not use it where it is dusty.
- Keep it as far from your TV as possible.

2. Power

- Check that the receiver is set for your local supply voltage and frequency. If not, consult the dealer from whom you bought it.
- Do not handle the power cord with wet hands!
- Do not bend the power cord sharply.
- When unplugging from the wall outlet, always pull the plug, not the power cord.

3. Malfunctions, etc.

- There are no user serviceable parts inside. If anything goes wrong, unplug the power cord and consult your dealer.
- Do not insert any metallic object inside the receiver.
- Do not allow water to get inside the receiver.
- This receiver contains a protective circuit which interrupts the sound when it operates. If the sound from your receiver is intermittent, it could be because of the operation of this circuit. In this case you should consult your dealer.

IMPORTANT (In the United Kingdom) Mains Supply (240V 50Hz AC only)

Warning: This apparatus must be earthed

This unit has a three-core mains lead which should be fitted with a 3-pin plug. The wires in the main lead are coloured in accordance with following code:

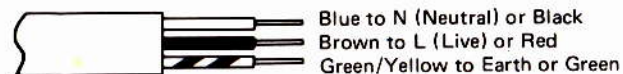

If these colours do not correspond with the terminal identifications of your plug, connect as follows:

Blue wire to terminal coded N (Neutral) or coloured Black.

Brown wire to terminal coded L (Live) or coloured Red.

Green/Yellow wire to the larger terminal coded E or Green.

If in doubt – consult a competent electrician.

Note

We recommend that you should disconnect the AC cord from the outlet.

CAUTION

To prevent electric shock, do not remove screws, covers or cabinet.

No user-serviceable parts inside. Refer servicing to qualified service personnel.

WARNING:

**TO PREVENT FIRE OR SHOCK
HAZARD, DO NOT EXPOSE THIS
APPLIANCE TO RAIN OR MOISTURE.**

FRONT PANEL

1. **SIGNAL strength meter**
This is used in tuning to broadcasts, both FM and AM. It makes its maximum deflection when the strength of the signal being received is greatest, i.e. when you are correctly tuned to a broadcast.
2. **FM TUNING meter**
This is used in tuning to FM broadcasts. It swings to the center position when you are tuned to the center frequency of the broadcast.
3. **FM STEREO indicator**
4. **POWER ON/OFF indicator**
This lamp lights up when the POWER switch is pressed in.
5. **POWER meters**
These meters indicate the output power in watts rather than the usual VU or uncalibrated units. The values in watts are indicated when one pair of speakers having an impedance of exactly 8 ohms is being driven. (See page 8.)
6. **TUNING control**
Turn lightly to tune to AM and FM broadcasts.
7. **VOLUME control**
Slide to the right to hear louder sound.
8. **BALANCE control**
This adjusts the balance between the left and right speakers. When it is at the left, you can hear only the left channel. When it is at the right, you can hear only the right channel.
9. **S.E.A. Graphic Equalizer tone control system**
These five controls allow you to boost and lower five sections of the frequency range by 12dB independently. For operation of these controls, which give far more flexible control over tone than the conventional bass/treble controls, see page 7. The preset patterns add to your listening pleasure with different types of music.
10. **Tuning dial**
11. **Illuminated dial pointer**
12. **Headphone jack (PHONES)**
Plug stereo headphones into this jack for private listening and recording monitoring. See page 6.
13. **Power switch**
Press to switch the power on and off. After the POWER switch is turned ON, no sound will be heard for 3 – 4 seconds. The protective circuit relay operates to put the circuitry on-line. You will hear a click from the relay operation at this time. This is not due to any defect in the set.
14. **SPK-1 switch**
Press to switch the speakers connected to the Speaker System 1 terminals on and off.

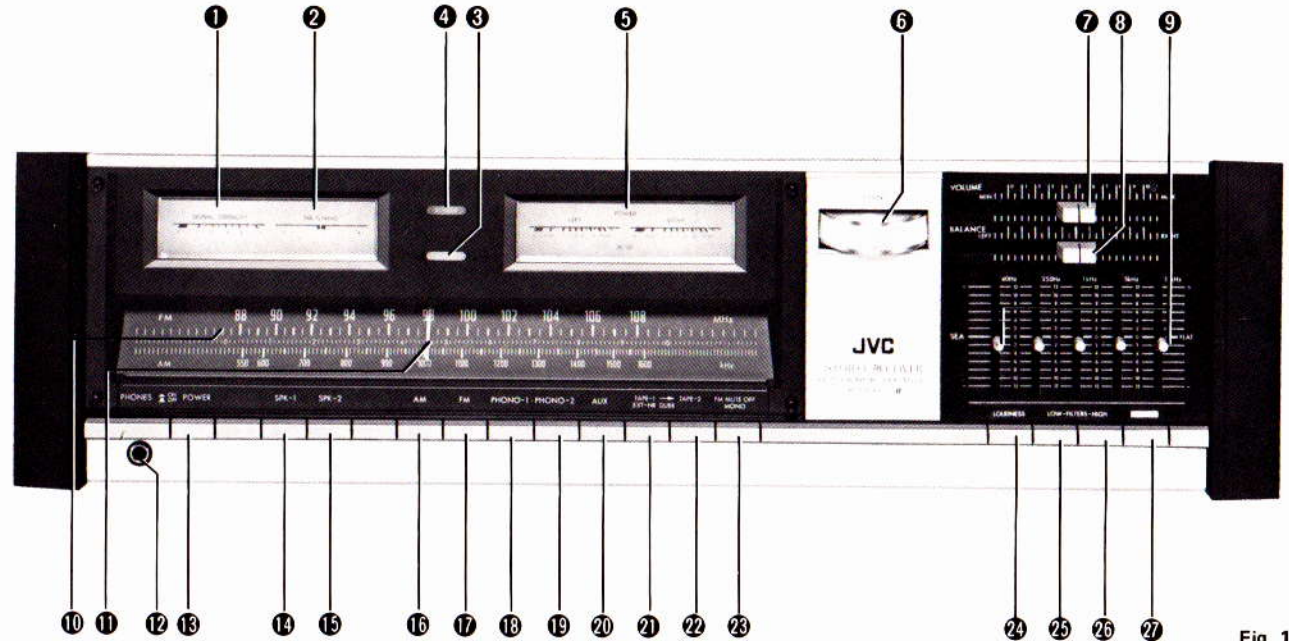

Fig. 1

15. **SPK-2 switch**
Press to switch the speakers connected to the Speaker System 2 terminals on and off.
16. **AM switch**
Press to switch on AM tuner section.
17. **FM switch**
Press to switch on FM tuner section.
18. **PHONO-1 switch**
Press to hear sound connected to PHONO-1 terminals on the rear panel.
19. **PHONO-2 switch**
Press to hear sound connected to PHONO-2 terminals on the rear panel.
20. **AUX switch**
Press to hear sound connected to AUX terminals.
21. **TAPE-1/EXT-NR switch**
Press to hear tape deck connected to the TAPE-1 terminals. When an external noise reduction unit is connected, this switch should be pressed in for its use.
22. **TAPE-2 switch**
Press to hear tape deck connected to the TAPE-2 terminals or TAPE-2 DIN socket.
23. **FM muting/mode switch (FM MUTE OFF/MONO)**
This controls the FM muting circuit and also acts as the mono/stereo mode switch. When it is in, a mixture of right and left channel sound will be heard from both speakers even if broadcasting is done in stereo. If it is pressed in when the reception of an FM stereo broadcast is sub-standard, it also switches off the FM muting circuit.
24. **LOUDNESS switch**
At low volumes, the tone of sound appears to change. This is not due to any change in the sound itself, but due to the ear's different sensitivity to sound at low volumes. Press to compensate for this when you are listening at low volumes.
25. **LOW FILTER switch**
Press to cut excessive bass or low frequency noise.
26. **HIGH FILTER switch**
Press to cut high frequency hiss or record surface noise.
27. **S.E.A. REC switch**
Press to record tapes with the added effect of the S.E.A. Graphic Equalizer.

CONNECTION DIAGRAM

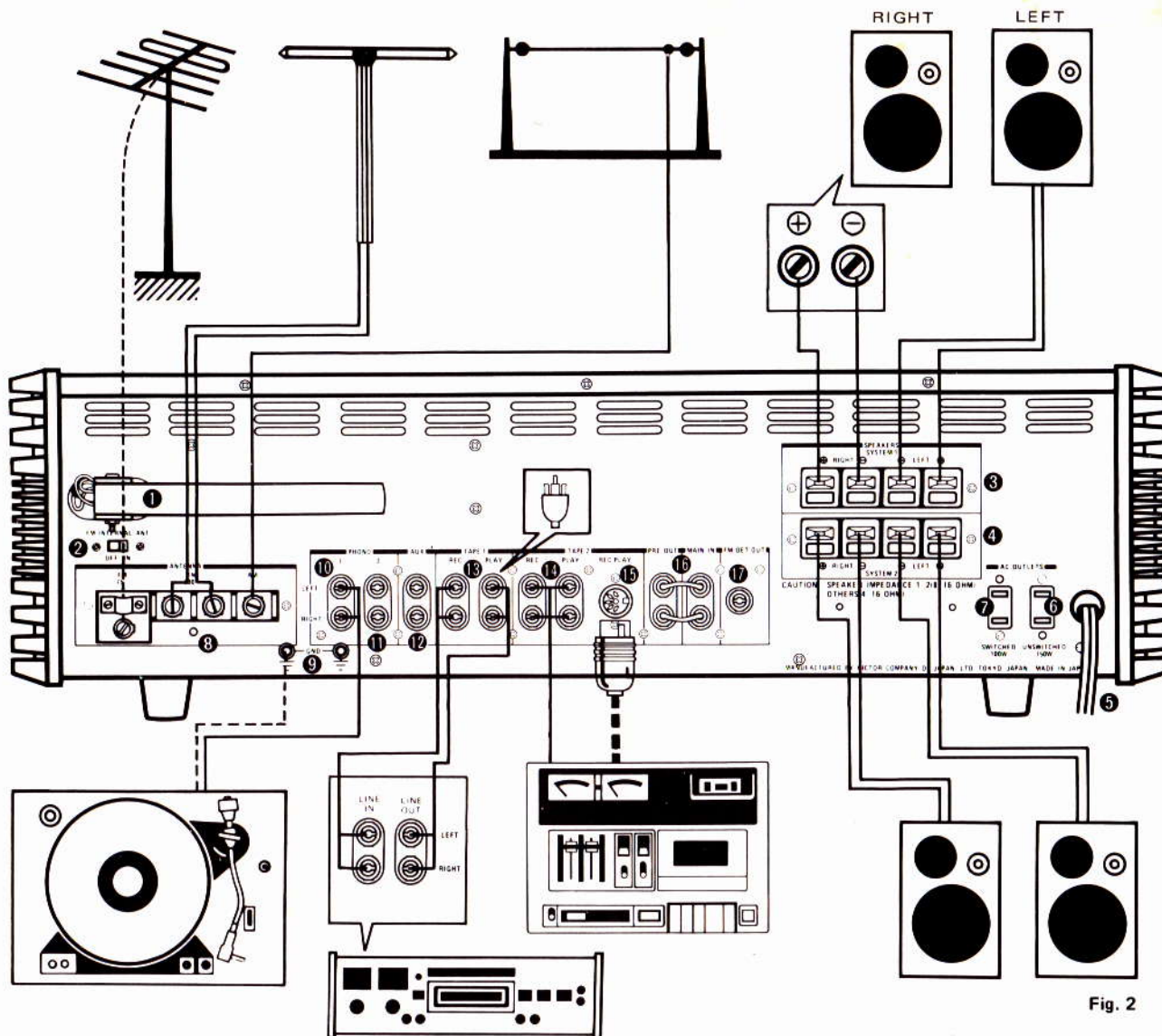

Fig. 2

1. AM ferrite bar antenna
2. FM INTERNAL ANTENNA switch
3. SPEAKERS SYSTEM 1 connection terminals
4. SPEAKERS SYSTEM 2 connection terminals
5. Power cord

6. UNSWITCHED AC OUTLET*
7. SWITCHED AC OUTLET*
- * (Not provided on sets for Continental Europe, the United Kingdom and Australia.)
8. External ANTENNA terminals
9. Ground terminals (GND)
10. PHONO-1 terminals
11. PHONO-2 terminals

12. AUX terminals
13. TAPE-1 terminals
14. TAPE-2 terminals
15. TAPE-2 DIN socket
16. PRE OUT/MAIN IN terminals
17. FM DET OUT terminal

NOTE

1. Connect source components with left and right channels connected correctly. Reversed channels will degrade the stereo effect.
2. Connect speakers with correct polarity; (+) to (+) and (-) to (-). Reversed polarity will degrade the stereo effect.
3. Switch the power off when connecting any component.
4. Connect plugs or wires firmly. Poor contact may result in hum.
5. Use speakers with correct impedances. When two pairs of speakers are to be driven simultaneously, their impedance should be between 8 and 16 ohms.
6. TAPE-2 terminals and DIN socket are in parallel. These cannot be used at the same time.
7. Do not connect equipment requiring more than the rated power to the AC outlets on the rear panel.
8. The UNSWITCHED AC outlet is not switched off when the front panel power switch is switched off. Connect it to a component which only uses power when operating, like a record turntable.
9. The SWITCHED AC outlet is switched off when the front panel power switch is switched off. Connect it to a component which must be switched off, like a tape deck.
10. If your record turntable has a separate ground lead, connect it to the GND terminal.
11. It is not necessary to connect both the 300Ω and 75Ω antennas simultaneously.

CONNECTING SPEAKERS

- Connecting speakers is very easy. Strip about 3/4" (2cm) of the end of the cord from the speaker, press the button below the hole, insert the stripped wire and release the button. The wire will now be held firmly and the electrical connection made.
- Two pairs of speakers can be connected. Connect the first pair to the upper row of terminals (SYSTEM-1) and the second (installed in another room, for example) to the lower row of terminals (SYSTEM-2).
- Be sure to connect with correct polarity, red to red or (+) and black to black or (-). If polarity is reversed, the stereo effect will be degraded.
- Be sure your speakers have the right impedance. When one pair of speakers is used, their impedance can be 4 – 16Ω. When two pairs of speakers are used simultaneously, their impedance should be between 8 and 16Ω.

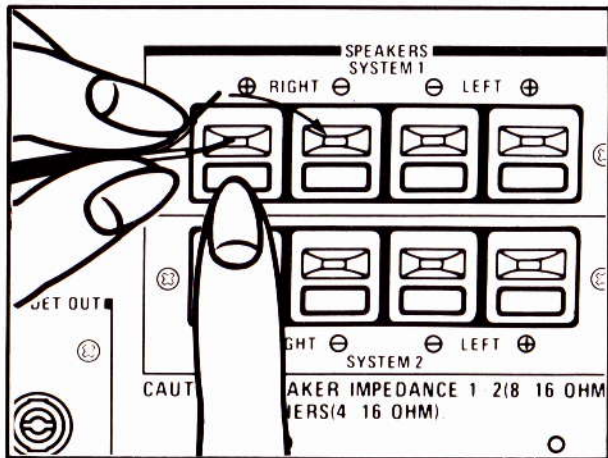

Fig. 3

ANTENNAS

AM ferrite bar antenna (Fig. 4)

This antenna is for the reception of local AM broadcasts. If it is too close to the rear panel, the metal of the rear panel will weaken broadcast waves. Move it away from the panel and set in the position where reception is best.

AM external antenna (Fig. 5)

If AM reception is not good, connect an external AM antenna (single-wire antenna) to the AM ANTENNA terminal. Even in this case, keep the ferrite bar antenna away from the rear panel.

FM built-in line antenna (Fig. 6)

The JR-S400 MARK II is equipped with a built-in FM line antenna. When receiving FM broadcasts, the FM internal ANTENNA switch should be ON. However, it is possible to connect an external FM antenna.

FM external antennas

When connecting an external FM antenna, first turn the "INTERNAL" antenna switch OFF.

- 75Ω antenna with coaxial lead (Fig. 7): Loosen the screws on the bracket and insert the cable into the ring from above. Then connect the stripped core to the lower screw terminal.
- 300Ω flat feeder antenna with two leads (Fig. 8): Connect to the two 300Ω terminals.

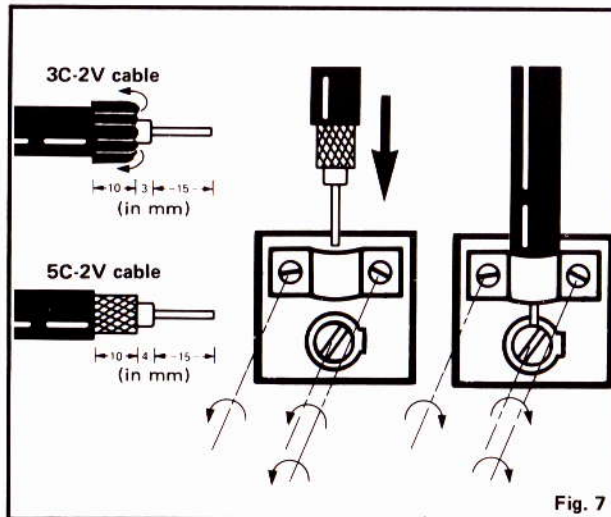

Fig. 7

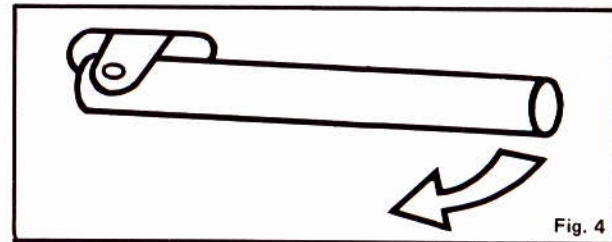

Fig. 4

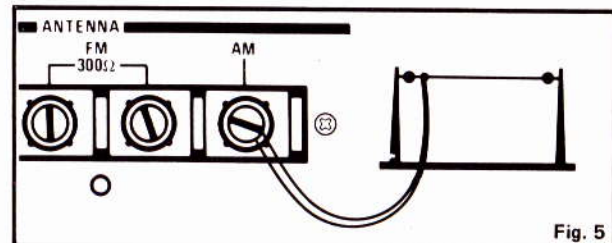

Fig. 5

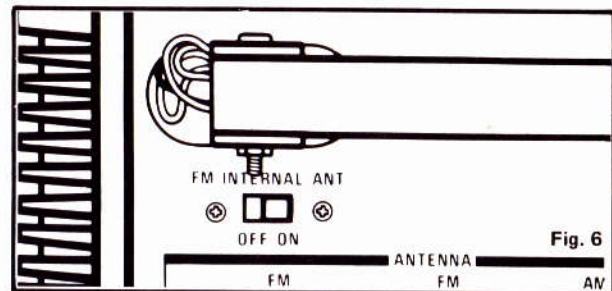

Fig. 6

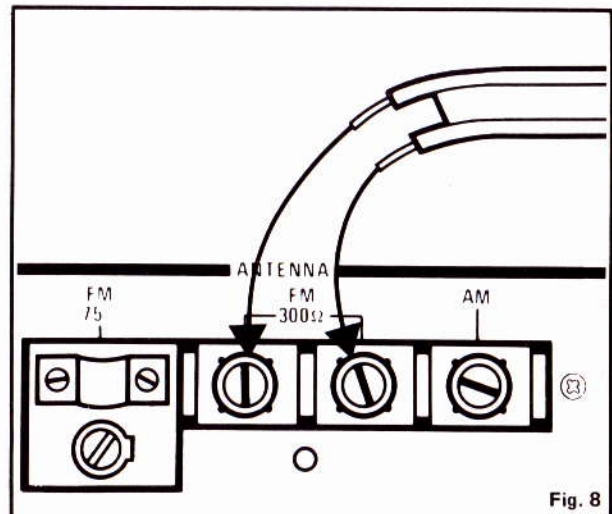

Fig. 8

BASIC

LISTENING TO AM BROADCASTS

1. Press the POWER switch to ON. The meters and dial pointer will be illuminated. The POWER ON/OFF indicator also lights up.
2. Press the SPK-1 or SPK-2 switch.
3. Press the AM switch.
4. Turn the tuning control to tune to the broadcast you want. Watch the signal strength meter. When it makes its biggest deflection, you are tuned correctly.
5. Adjust the volume and balance to your requirements and use the S.E.A. controls, loudness switch, high and low filter switches to obtain the tone you want to hear.

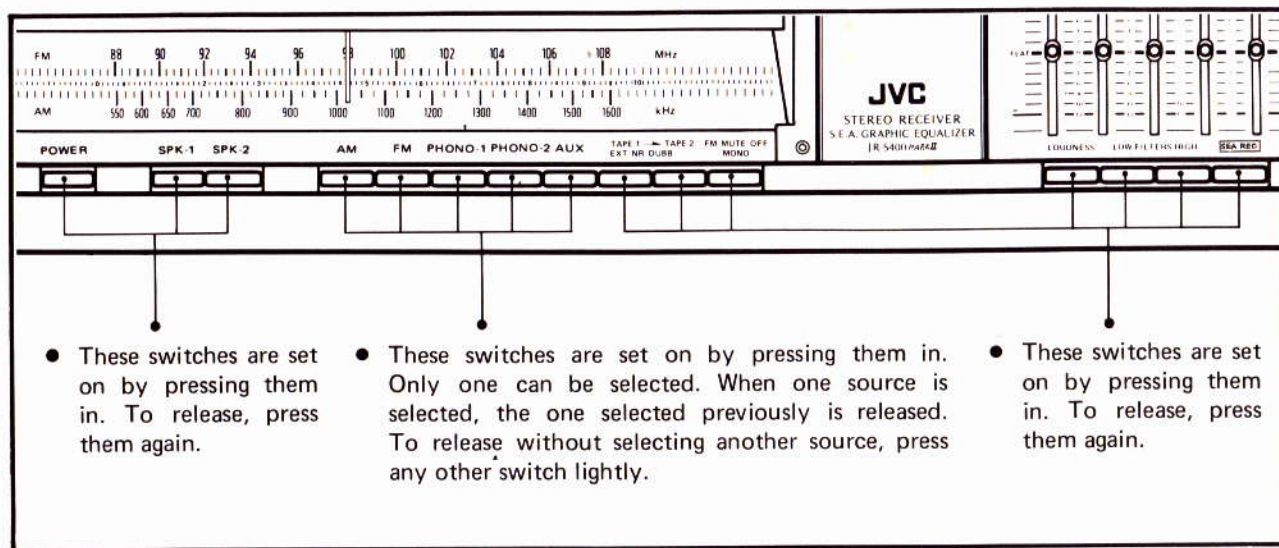

Fig. 9

Fig. 10

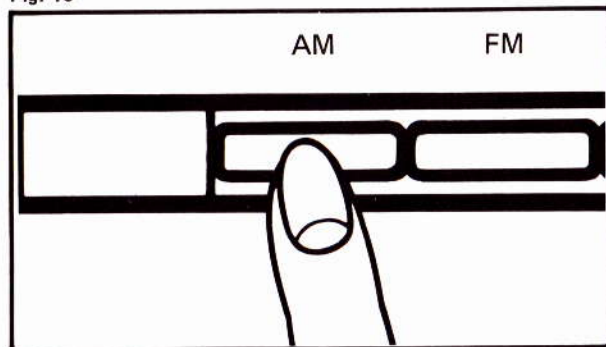
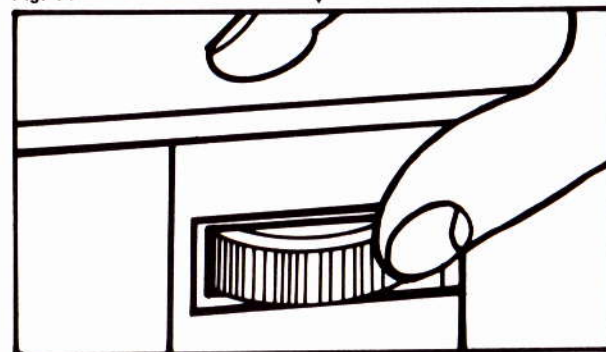

Fig. 11



LISTENING TO FM BROADCASTS

1. Press the POWER switch.
2. Press the SPK-1 or SPK-2 switch.
3. Press the FM switch.
4. Tune to the broadcasts you want.

● Meters

SIGNAL strength meter: makes its biggest deflection when signal is strongest.

FM TUNING meter: swings to center when you are tuned to center frequency.

- **The FM STEREO indicator** lights to show you are tuned to a stereo broadcast.
- **FM MUTE OFF/MONO switch**
Use this when FM reception is sub-standard. It decreases the noise level by combining the left and right channels into one monaural signal which can be heard from both speakers.

Fig. 12

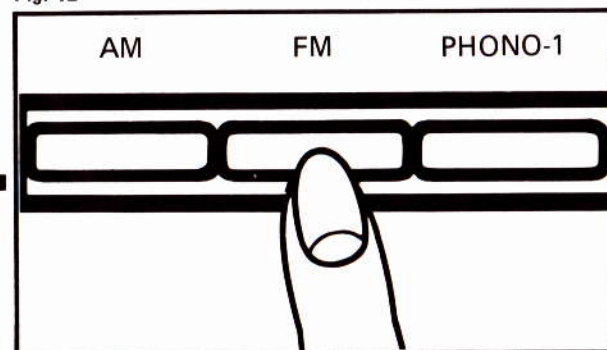
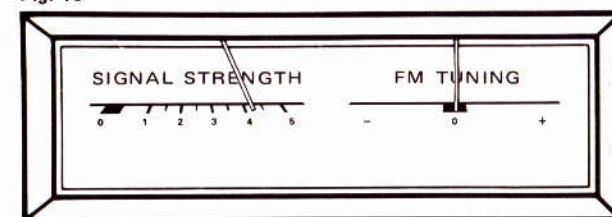
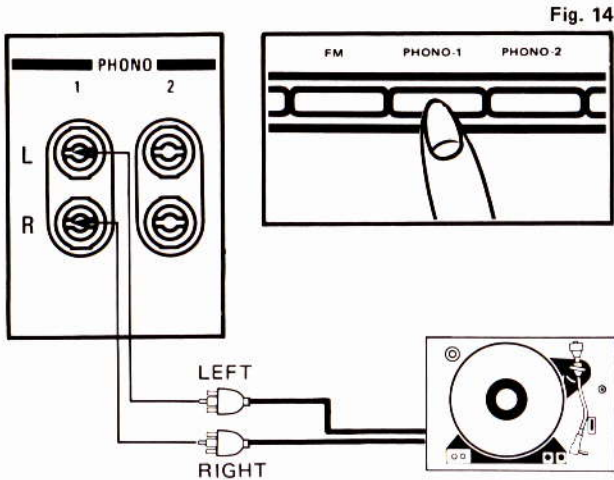

Fig. 13



LISTENING TO RECORDS

1. Connect a magnetic cartridge turntable to the PHONO-1 or PHONO-2 terminals on the rear panel. Be careful to connect the channels correctly.
2. Press the POWER switch.
3. Press the SPK-1 or SPK-2 switch.
4. Press the PHONO-1 or PHONO-2 switch corresponding to the connection.
5. Operate the turntable as described in its operation manual.
6. Adjust volume, balance and tone.



USING STEREO HEADPHONES

Stereo headphones can be plugged into the front panel jack. The signal from this jack is independent of the speakers.

1. Plug stereo headphones into the front panel PHONES jack.
2. For private listening, set both SPEAKERS switches OFF.
3. To listen to headphones at the same time as listening to speaker sound, press the required SPEAKERS switch.

LISTENING TO TAPES

1. Connect a tape deck to the TAPE-1 or TAPE-2 PLAY terminals. If your tape deck has a DIN socket, connect with a DIN cable to the TAPE-2 DIN socket for both playback and recording.
2. Press the POWER switch.
3. Press the SPK-1 or SPK-2 switch.
4. Press the TAPE-1 or TAPE-2 switch corresponding to the connection.
5. Operate the tape deck for playback as described in its operation manual.

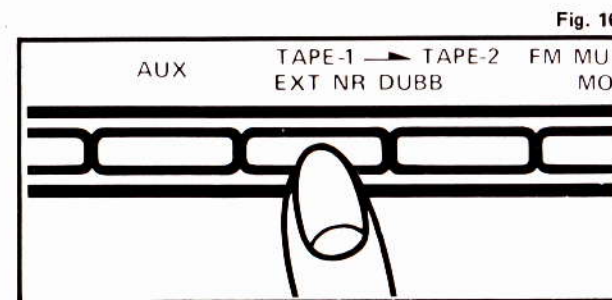
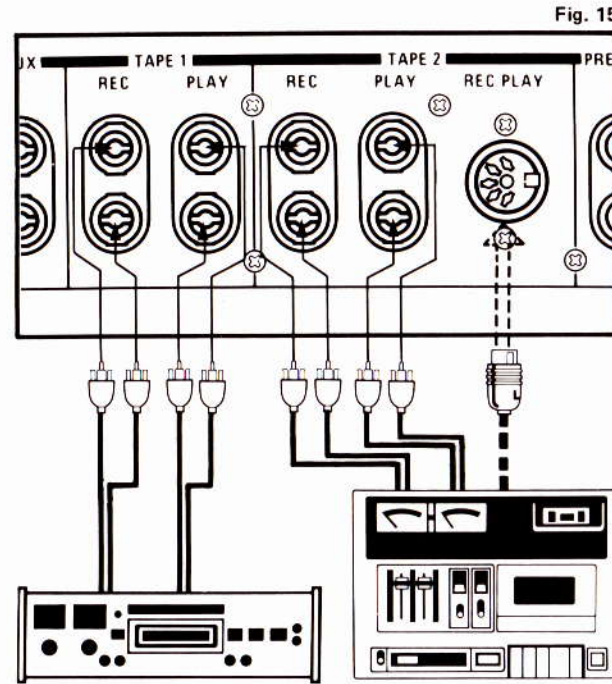

RECORDING TAPES

Recording from disc records

1. Connect a tape deck to the TAPE-1 or TAPE-2 REC terminals. If you have made DIN connection, no further connection is necessary.
2. Press the POWER switch.
3. Press the SPK-1 or SPK-2 switch if you want to hear the sound while recording.
4. Operate the turntable.
5. Operate the tape deck for recording.

Notes:

- You can also monitor the sound being recorded with the headphones.
- The sound you hear from the speakers or headphones is the source sound (disc record playback sound in this case), not the recordings on the tape.
- If you have a three-head tape deck with independent record and playback heads, you can monitor the recorded sound while recording by pressing the TAPE-1 or TAPE-2 switch.

Recording from other sources (AM, FM and AUX)

Press the switch corresponding to the source to be recorded. All other operations are identical to when recording from disc records.

S.E.A. RECORDING

The built-in S.E.A. Graphic Equalizer tailors the sound to your own particular taste or compensate for room acoustics or system characteristics as described in the ADVANCED section, page 7. The JR-S400 MARK II is equipped with an SEA REC switch which makes available a recording output with the added effect of S.E.A. First set the S.E.A. controls as required. Press the SEA REC switch, then proceed the same way as in normal recording. Your recordings will have the S.E.A.-compensated sounds. Employ this facility for recording enjoyment with that personal touch.

Notes:

- S.E.A. recording is possible only with the tape deck connected to the TAPE-1 terminals.
- When using a three-head tape deck, you may wish to monitor the sound being recorded. However, avoid this during S.E.A. recording since oscillations may occur which cause speaker howl.
- Moving the VOLUME control during S.E.A. recording varies the recording level. The control should remain in same position throughout the recording.

ADVANCED

S.E.A. PRESET PATTERNS

Try these patterns to increase your listening pleasure with different types of music. These are suggestions from JVC of settings which will be most suitable for these types of tunes.

Fig. 17

1. The spoken word

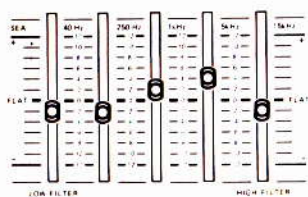

2. Tenor saxophone

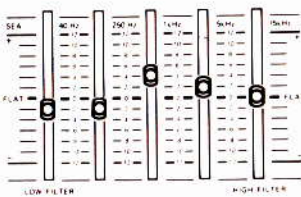

3. Party time

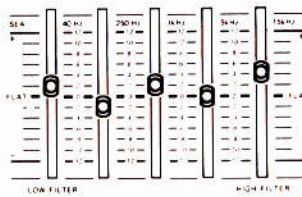

4. Background music

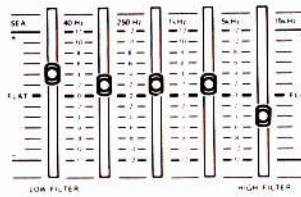

5. Latin

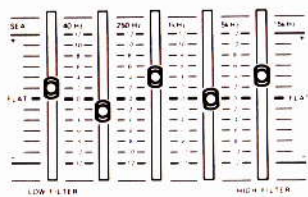

6. Heavy drums and bass

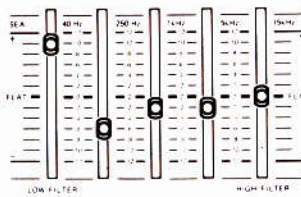

7. Soprano

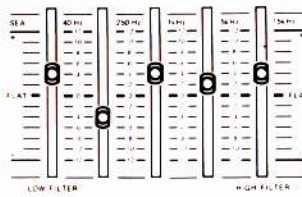

8. Rhythm with highs

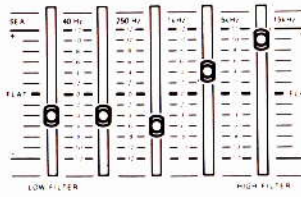

9. Clear and crisp sound

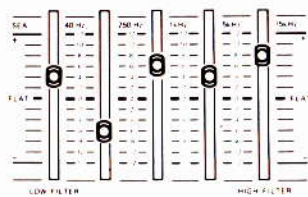

10. Ideal for popular songs

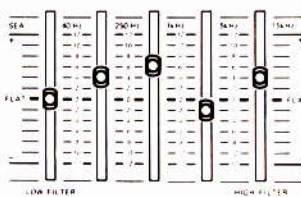

11. Reinforces rhythm

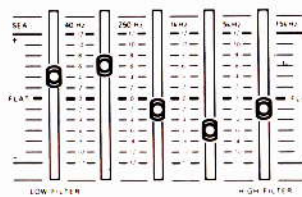

12. Private listening with headphones

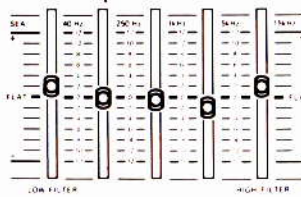

SOME MORE ABOUT S.E.A.

JVC's exclusive tone control system

S.E.A. splits the receiver's output into five frequency bands with center frequencies of 40, 250, 1,000, 5,000 and 15,000Hz. The controls have click positions above and below the center or FLAT position so that the response in each band can be varied by $\pm 12\text{dB}$.

40Hz Boost to bring out the rich tones of such instruments as the organ.

250Hz Boost to add clarity to upper bass sounds such as woodwind instruments and cellos. Cut to eliminate speaker boom.

1,000Hz Effective to emphasize or deemphasize the human voice and certain instruments.

5,000Hz Boost to add clarity to trumpets and violins. Cut to reduce upper mid-range response.

15,000Hz Boosts high frequency response and gives a feeling of presence.

S.E.A. makes possible more flexible control over tone so that various special effects can be obtained that were not possible with conventional bass and treble tone control systems. With S.E.A. used judiciously, the sound can be tailored to compensate for the acoustic properties of your listening room, the characteristics of your audio system and the properties of different types of music.

Compensation for room acoustics

Rooms with many curtains and furnishings tend to absorb low frequency sound, in which case the 40Hz and 250Hz controls should be boosted. In rooms which are relatively sparsely furnished, sound is reflected. In small rooms highs tend to be emphasized and in large rooms, lows. These different properties can be compensated for by proper adjustment of S.E.A.

Compensation for the characteristics of components

Almost all moving magnet cartridges have peaks in their response curves between 10,000 and 15,000Hz and produce harsh high frequency sounds. Speakers also are not always perfect. Some airtight enclosures reproduce low frequencies below 100Hz poorly and cause harsh sounding midrange and high frequencies. These characteristics of audio systems, which cannot be compensated for by conventional tone control systems, can be perfectly compensated for by S.E.A.'s five controls.

POWER METERS

All audio components with built-in power amplifiers have rated power outputs and all speakers have rated power handling capacities. Instead of the usual level meters, the JR-S400 MARK II is equipped with power meters which are directly related to the power being fed to the speakers. They indicate the power in watts when one pair of speakers having an impedance of exactly 8 ohms is being driven. They are convenient for several reasons:

Output level monitoring

You can find what wattage is most suitable in your own listening room so you can always adjust precisely. The meters will also give you an idea of the loudness produced by an indicated wattage.

Right and left channel balancing

When you adjust the balance between the right and left channels, watch the meters. To balance accurately, the MONO mode should be used so that the right and left channel signals are exactly the same. Adjust the BALANCE control so that the deflections of the meter needles are equal.

Checking actual speaker power handling capacity

You can check to make sure that you are not exceeding the power handling capacity of your speakers while listening at your preferred volume level. Monitoring the actual output power level can also help you achieve top performance when you select a new speaker system.

Fig. 18

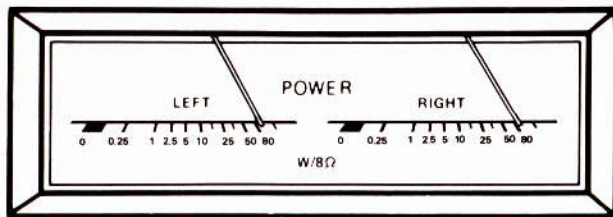

TAPE DUBBING

Tape dubbing means copying the contents of one tape to another tape. To perform tape dubbing two tape recorders should be connected, the one from which the copy is to be made (called "TAPE-1 tape deck") to the Tape-1 terminals and the one to which the copy is to be made (called "TAPE-2 tape deck") to the Tape-2 terminals or Tape-2 DIN socket.

1. Operate the TAPE-1 tape deck for playback.
2. Listen to the tape pressing the TAPE-1 switch.
3. Operate the TAPE-2 tape deck for recording.

Fig. 19

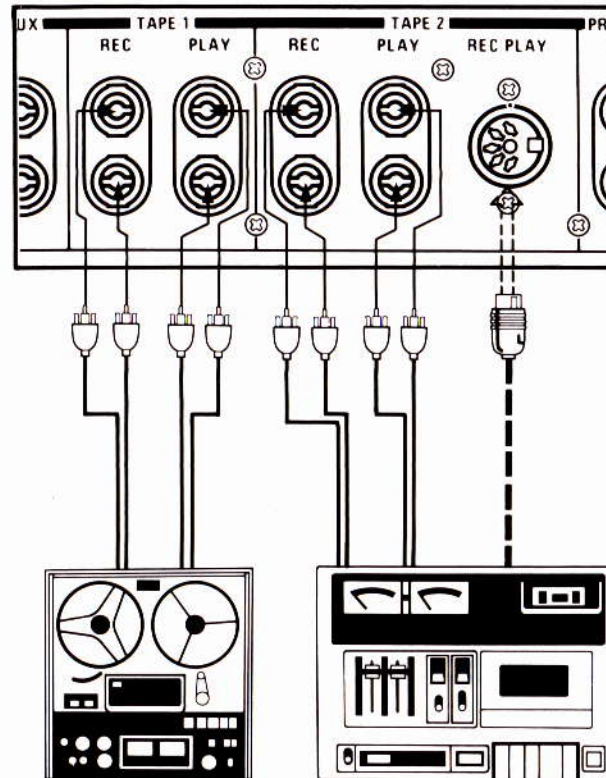

Notes:

- Dubbing from TAPE-2 to TAPE-1 is impossible.
- If you press the TAPE-2 switch while dubbing, no sound is heard from the speakers.
- If a three-head tape deck is used as the TAPE-2 tape deck, you can monitor the recordings immediately after they have been made by pressing the TAPE-2 switch.
- When two tape decks are connected, either can be heard by pressing the TAPE-1 or TAPE-2 switch. If both the TAPE-1 and TAPE-2 switches are depressed, TAPE-2 has priority and you can only hear TAPE-2. To hear TAPE-1, first release the TAPE-2 switch by pressing it again.

Fig. 20

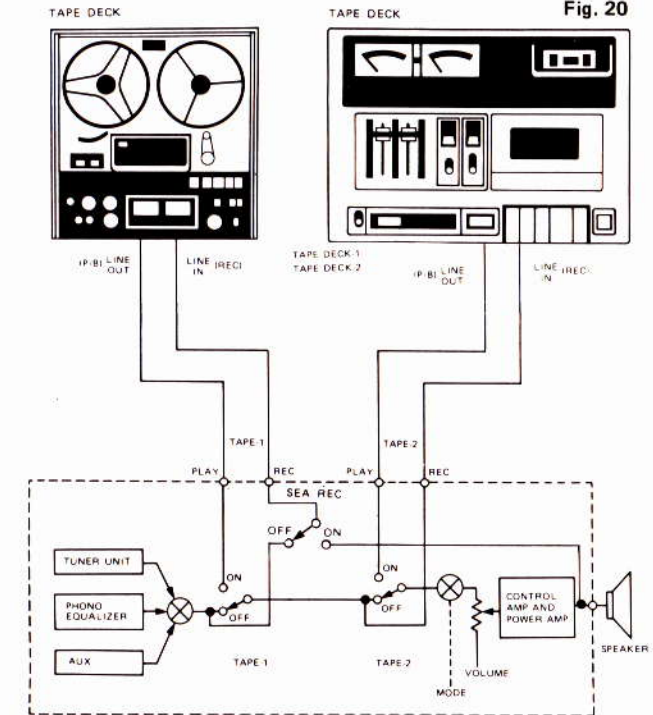

CONNECTING NOISE REDUCTION UNIT

In certain areas, noise-reduction processed FM programs are broadcast. These programs have been processed in the same way as certain tapes are processed, with low level, high frequency sounds boosted before transmission. To reproduce these correctly they must be noise-reduction processed in the reception system to de-emphasize the boosted sounds before you hear them. With the addition of a noise reduction unit (NR unit), these broadcasts can be enjoyed by owners of the JR-S400 MARK II.

Connection

- Connect the NR unit to the TAPE-1 terminals of the receiver. The NR unit's output terminals should be connected to the PLAY terminals and its input terminals should be connected to the REC terminals.
- The SEA REC switch should be OFF.

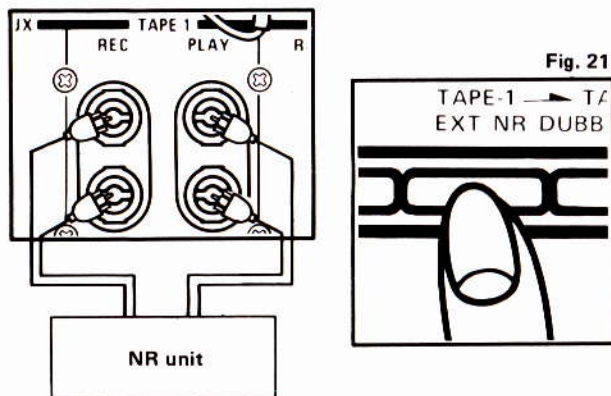

Operation

1. Press the FM switch.
2. Press the TAPE-1/EXT NR switch.
3. Other operations are as for listening to FM broadcasts.

Note:

- The NR unit can also be used with your tape deck to make and play back noise-reduction processed recordings with improved S/N. In this case it should be connected to your receiver and tape deck in a different way. For details concerning this connection, refer to the instructions accompanying the noise reduction unit.

USING THE PRE OUT/MAIN IN TERMINALS

These terminals are used to connect components for more sophisticated audio systems. Although the JR-S400 is an integrated receiver, its preamplifiers and main amplifiers can be separated for use in complex systems. The illustration shows a multi-channel amplifier system in which the output from the PRE OUT terminals is passed through a multi-channel filter which splits the sound spectrum into three frequency zones for independent amplification and reproduction. In this diagram, the JR-S400 MARK II is employed as a low frequency amplifier, with the low frequency output of the multi-channel filter connected to the MAIN IN terminals.

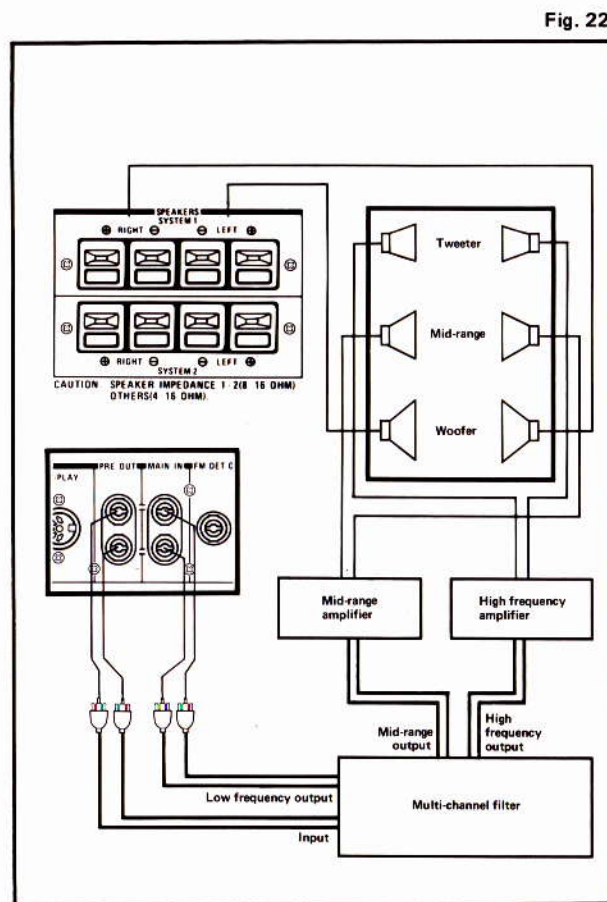

FM DET OUT

The signal detected by the FM tuner is available at the FM DET OUT terminal on the rear panel. This is for the connection of an FM demodulator when FM 4-channel broadcasting starts.

The signal is fed from the FM DET OUT terminal to the demodulator.

This demodulator will have 4 output terminals, for front left and right channels and back left and right channels. Feed the front channel signals into the JR-S400 MARK II and the rear channel signals into another stereo amplifier.

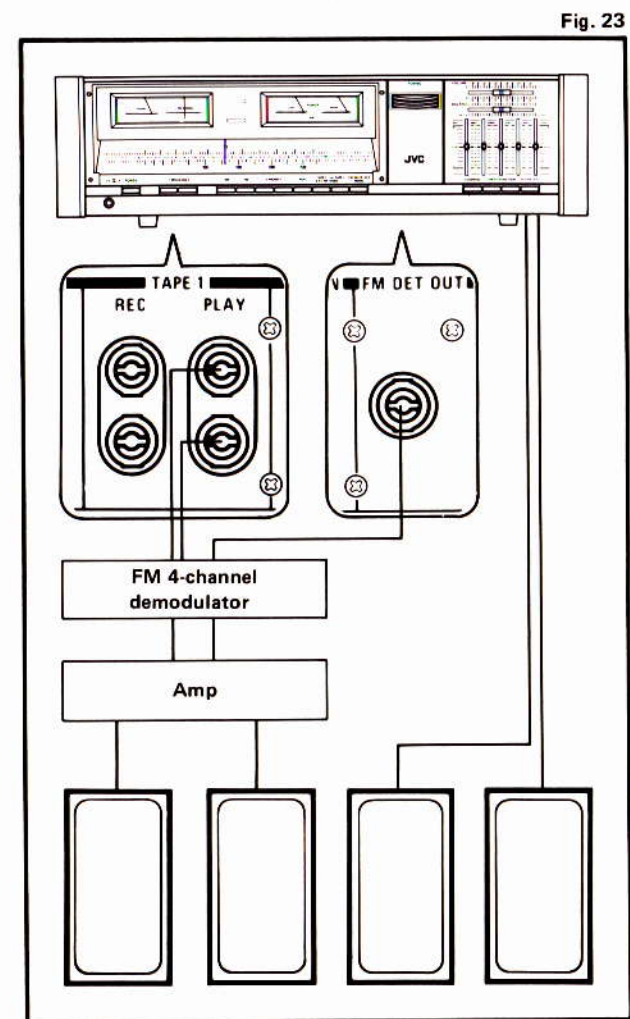

TROUBLESHOOTING

What seems to be trouble is not always real trouble.
Make sure first.

If this happens..... Check!

No sound and no illumination

Is the AC plug connected properly?

No sound from speakers

Are speaker cords connected?
Are speaker switches pressed in?
Is VOLUME control at MIN?
Is TAPE-1 or TAPE-2 switch pressed in when listening to other sources?
— If either of them is pressed in, AM, FM, PHONO-1, PHONO-2 or AUX cannot be heard.
Are the wires between PRE OUT and MAIN IN terminals out of place?

Sound from one speaker only

Are speaker cords connected correctly?
Is BALANCE control set to one extreme or the other?

Continuous hiss or buzzing during FM reception

Incoming signal is too weak.
Use correct antenna.

Occasional crackling noise during FM reception

This may be automobile ignition noise. Move antenna as far away from the road as possible.

Loud hum during record playing

Is turntable grounded?
Try to change cord path.

Howling noise during record playing

Is turntable too close to speaker?

Design and specifications subject to change without notice.

SPECIFICATIONS

POWER AMPLIFIER SECTION

Output Power : 80 watts per channel, min. RMS, both channels driven, into 8 ohms from 20 Hz to 20 kHz, with no more than 0.08 % total harmonic distortion
85 watts per channel into 8 ohms (1 kHz, THD 0.08 %)
110 watts per channel into 4 ohms (1 kHz, THD 0.08 %)

Intermodulation Distortion : 0.1 % at rated output
Damping Factor : 50 at 8 ohms
Load Impedance : 4 – 16 Ω (SYSTEM 1 or 2)
8 – 16 Ω (SYSTEM 1 + 2)

PRE-AMPLIFIER SECTION

Input Sensitivity (Impedance) : PHONO 2.5 mV (50 k Ω)
AUX 220 mV (60 k Ω)
TAPE PLAY 220 mV (60 k Ω) (Pin, DIN)
Signal-to-Noise Ratio (IHF Short-Circuit A Network) : PHONO 75 dB
AUX 95 dB
TAPE 95 dB
Recording Output : Pin 180 mV
DIN 30 mV (80 k Ω)

Phono Equalizer Deviation : \pm 0.5 dB from RIAA Curve
Phono Overload : 200 mV (RMS, 1 kHz)

S.E.A. TONE CONTROL SECTION

S.E.A. Center Frequencies : 40, 250, 1 k, 5 k, 15 kHz
S.E.A. Control Range : \pm 12 dB

FM TUNER SECTION

Usable Sensitivity : 9.8 dBf (1.7 μ V)
50 dB Quieting Sensitivity : MONO 16.1 dBf (3.5 μ V)
STEREO 36.8 dBf (38 μ V)
Stereo Separation (at REC OUT) : 50 dB (1 kHz)
35 dB (50 Hz – 10 kHz)
Distortion : 100 Hz 0.1 % (MONO)
0.25 % (STEREO)
1 kHz 0.1 % (MONO)
0.25 % (STEREO)
6 kHz 0.25 % (MONO)
0.4 % (STEREO)

Signal-to-Noise Ratio (IHF weighted) : MONO 80 dB
STEREO 70 dB

Alternate Channel Selectivity : 80 dB
Capture Ratio : 1.0 dB
Image Response Ratio : 90 dB

IF Response Ratio : 100 dB
AM Suppression : 55 dB
FM DET Output : 100 mV (10 k Ω)
Muting Threshold : 19.2 dBf (5 μ V)

AM TUNER SECTION

Sensitivity : 300 μ V/m (Bar antenna)
30 μ V (Ex. antenna)

Signal-to-Noise Ratio : 55 dB
DIMENSIONS : 56.0 cm(W) x 16.9 cm(H) x 43.1 cm(D)
(22-1/16" x 6-11/16" x 17")

WEIGHT : 17.0 kg (37.4 lb.)



POWER SPECIFICATIONS

	Line Voltage & Frequency	Power Consumption
U.S.A.	AC 120V, 50/60Hz	220 watts (By UL Standard)
CANADA	AC 120V, 50/60Hz	440VA (By CSA Standard)
CONTINENTAL EUROPE	AC 220V~, 50Hz	620 watts (By IEC Standard)
U.K., AUSTRALIA	AC 240V~, 50Hz	620 watts (By BS and SAA Standards)
OTHER AREAS	AC 100/120/220/240V Selectable, 50/60Hz	220 watts